

	Value	Unit
	-30	V
	-1.6	V
	-55	A
	6.1	mΩ
$R_{DS(ON\_Typ)}(@V_{GS}=-4.5V)$	8.9	mΩ

### Ordering Information

Device	Marking	MSL	Form	Package	Reel(pcs)	Per Carton (pcs)
JMTK100P03A	JMTK100P03A	3	Tape&Reel	TO-252-3L	2500	25000

### Absolute Maximum Ratings (@ $T_C = 25^\circ\text{C}$ unless otherwise specified)

Symbol	Unit
$V_{DS}$	V
$V_{GS}$	V
$I_{DM}$	A
$E_{AS}$	mJ
$T_J$ STG	$^\circ\text{C}$

$T_C = 25^\circ\text{C}$   
 $T_C = 100^\circ\text{C}$

### Thermal Characteristics

Symbol	Parameter	Max	Unit
R	Thermal Resistance, Junction to Ambient <sup>(3)</sup>	41	$^\circ\text{C}/\text{W}$
R	Thermal Resistance, Junction to Case	2.9	$^\circ\text{C}/\text{W}$

**Electrical Characteristics** ( $T_J = 25^\circ\text{C}$  unless otherwise specified)

Symbol	Conditions	Min.	Typ.	Max.	Unit
<b>Off Characteristics</b>					
$V_{(BR)DSS}$		-30	-	-	V
$I_{DSS}$		-	-	-1.0	$\mu$
$I_{GSS}$		-	-	$\pm 100$	
<hr/>					
$V_{GS(th)}$		-1.1	-1.6	-2.5	V
		-	6.1	10.0	m $\Omega$
		-	8.9	16.0	m $\Omega$
<hr/>					
$R_g$		-	5.6	-	$\Omega$
$C_{iss}$		2489	3485	4705	pF
$C_{oss}$		283	397	536	pF
$C_{rss}$		240	336	454	pF
$Q_g$		44	62	83	nC
$Q_{gs}$		7	10	13	nC
$Q_{gd}$		9	12	16	nC
<hr/>					
$t_{d(on)}$		-	16	-	ns
$t_r$		-	62	-	ns
$t_{d(off)}$		-	55	-	ns
$t_f$		-	70	-	ns
<hr/>					
$I_S$		-	-	-55	A
$I_{SM}$		-	-	-221	A
$V_{SD}$		-		1.2	V
$t_{rr}$		15	22	29	ns
$Q_{rr}$		-	11.5	-	nC

Notes: 1. Repetitive Rating: Pulse Width Limited by Maximum Junction Temperature.

2.  $E_{ASD}$  Condition: Starting  $T_J=25^\circ\text{C}$ ,  $V_{DD}=-15\text{V}$ , V

## Typical Performance Characteristics

## Typical Performance Characteristics

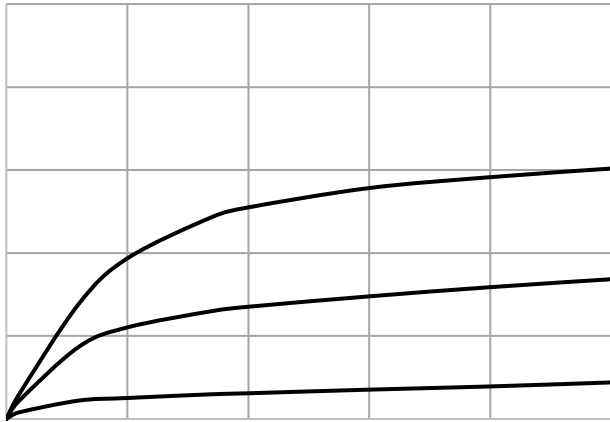



### Typical Performance Characteristics

Figure 11: Normalized Breakdown voltage vs. Junction Temperature

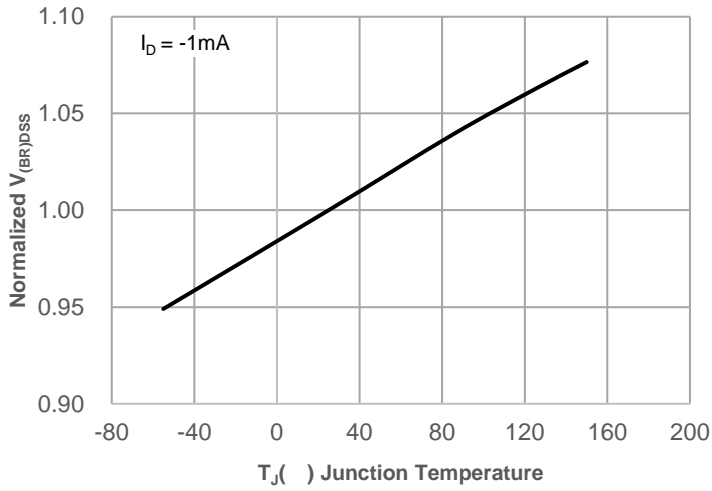

Figure 12: Normalized on Resistance vs. Junction Temperature

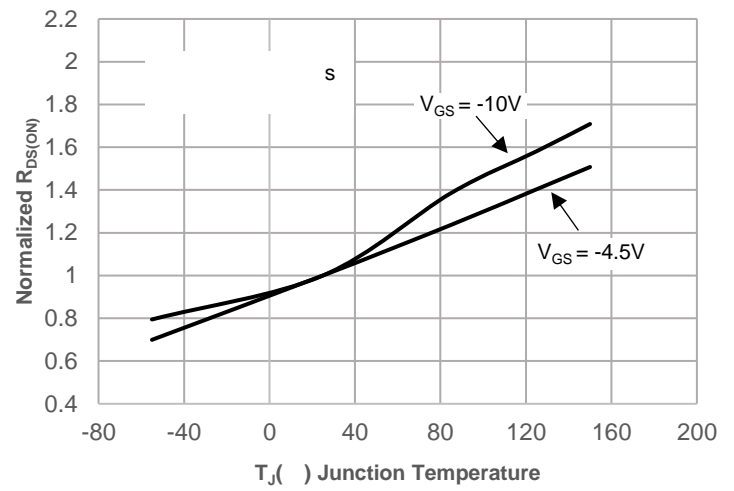

Figure 13: Normalized Threshold Voltage vs. Junction Temperature

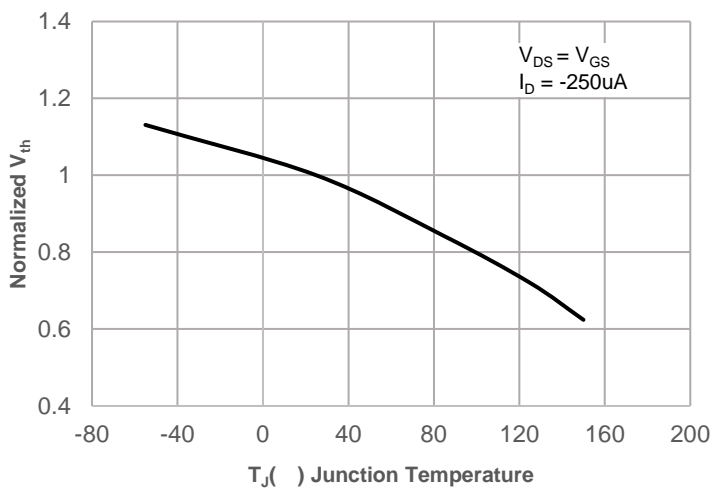

Figure 14:  $R_{DS(ON)}$  vs.  $V_{GS}$

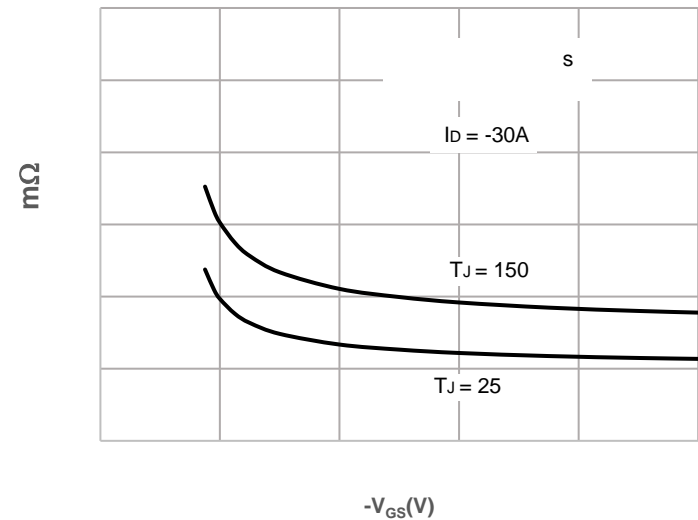
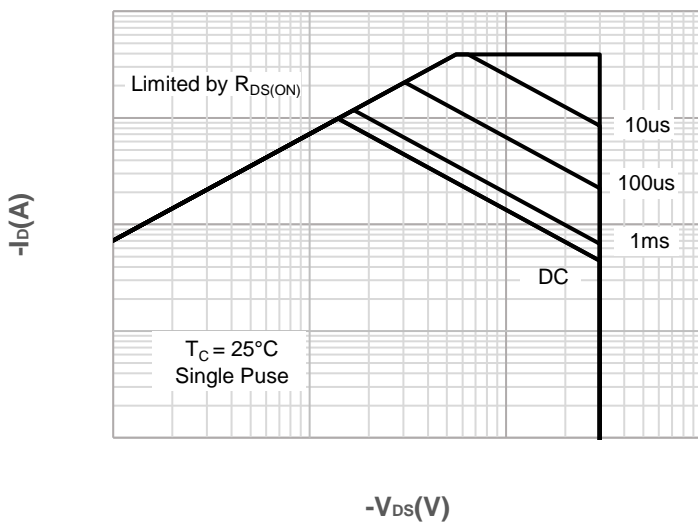

Figure 15: Maximum Safe Operating Area



### Test Circuit

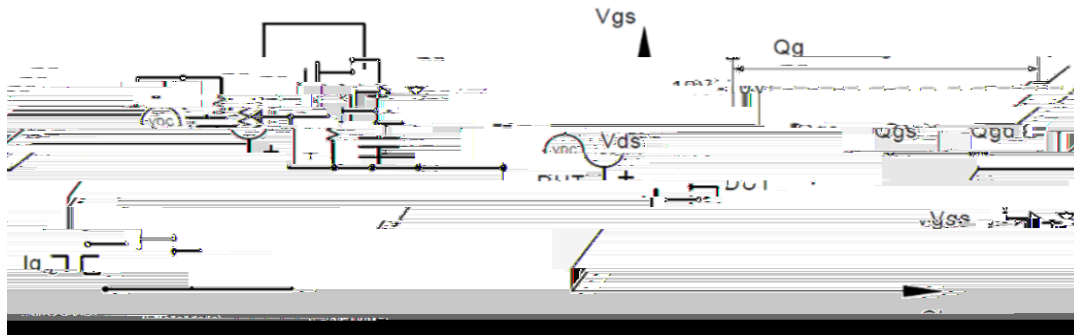

Figure 1: Gate Charge Test Circuit & Waveform

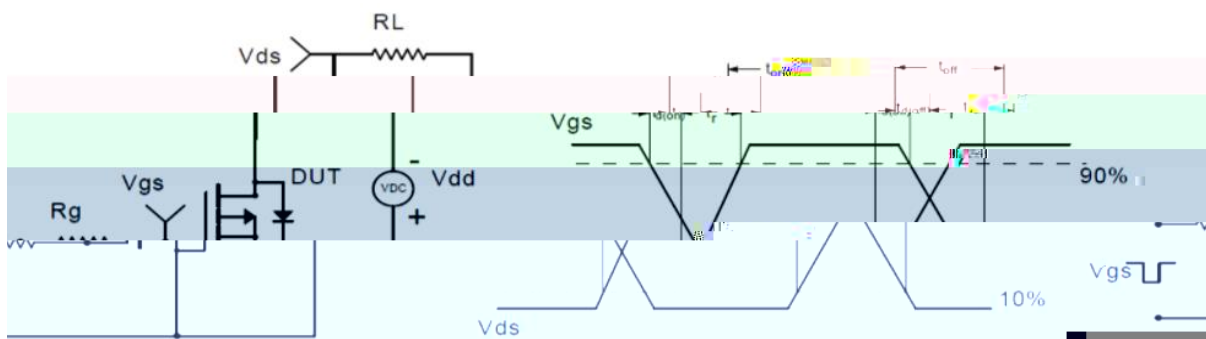

Figure 2: Resistive Switching Test Circuit & Waveform

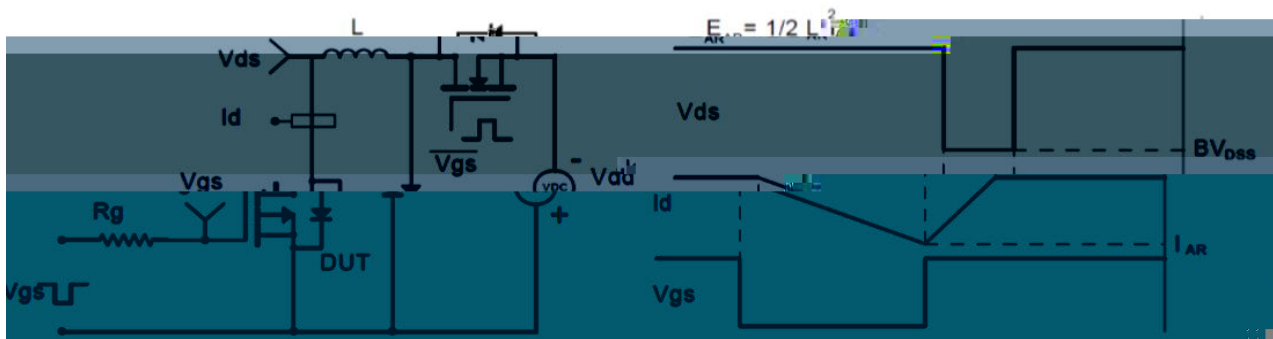

Figure 3: Unclamped Inductive Switching Test Circuit & Waveform



Figure 4: Diode Recovery Test Circuit & Waveform



**Package Mechanical Data(TO-252-3L)**